

IBPS Clerk Preliminary Grand Test –ICP-181130

HINTS & SOLUTIONS

ANSWER KEY

1. (4)	21. (1)	41. (4)	61. (4)	81. (2)
2. (3)	22. (2)	42. (1)	62. (2)	82. (3)
3. (1)	23. (5)	43. (4)	63. (1)	83. (1)
4. (2)	24. (4)	44. (5)	64. (3)	84. (1)
5. (2)	25. (2)	45. (1)	65. (2)	85. (1)
6. (2)	26. (2)	46. (2)	66. (3)	86. (1)
7. (2)	27. (3)	47. (2)	67. (2)	87. (1)
8. (1)	28. (2)	48. (3)	68. (1)	88. (4)
9. (3)	29. (5)	49. (1)	69. (1)	89. (4)
10. (3)	30. (4)	50. (4)	70. (2)	90. (2)
11. (2)	31. (1)	51. (2)	71. (5)	91. (2)
12. (4)	32. (1)	52. (4)	72. (4)	92. (5)
13. (5)	33. (2)	53. (4)	73. (5)	93. (4)
14. (1)	34. (5)	54. (2)	74. (1)	94. (2)
15. (3)	35. (3)	55. (3)	75. (3)	95. (2)
16. (2)	36. (3)	56. (1)	76. (2)	96. (2)
17. (4)	37. (1)	57. (3)	77. (3)	97. (4)
18. (3)	38. (3)	58. (5)	78. (1)	98. (2)
19. (3)	39. (3)	59. (2)	79. (1)	99. (2)
20. (3)	40. (5)	60. (4)	80. (2)	100. (5)

HINTS & SOLUTIONS

1. (4) The use of article 'an' before the adjective 'intelligent' is incorrect. When two adjectives are used for the same person, then the article is used before the first adjective only.
Hence, there is an error in (D), and option (4) is the correct answer.
2. (3) When 'one of' is followed by two nouns, then we don't tell the possession or ownership with the use of 's but with the help of 'of'. The reason is that after 'one of' noun is plural, and thus, if two nouns are used, then it becomes more difficult to determine which of the noun is plural. In such cases, the expression starts giving double-meaning. The correct phrase would be 'the farmhouse of one of the CBI officers'.
Hence, there is an error in the part (C), and option (3) is the correct answer.
3. (1) Instead of the singular 'conversation', the noun 'conversation' should be plural i.e. 'conversations'. So, there is an error in the part (A) of the sentence, and option (A) is the correct answer.
4. (2) An article would be used before the noun 'rich'.
Hence, there is an error in the part (B), and option (2) is the correct answer.
5. (2) The noun 'woman' in the part (B) should be plural i.e. 'women' because the expression 'among those' indicates that there is more than one woman. So, there is an error in the part (B) of the sentence, and hence, option (2) is the correct answer.
6. (2) 'were' would be used instead of 'was' in the part (B) because the subject of the verb phrase 'was seen' is 'Five kilometres' which is a plural noun. So, there is an error in the part (B) and option (2) is the correct answer.
7. (2) Instead of 'lived', 'has lived' or 'has been living' would be used because the tense of the sentence is **present tense** which is evident from the phrases 'is sitting' present in the part (A) and 'has never created' in the part (C).
So, there is an error in the part (B) of the sentence, and option (2) is the correct answer.
8. (1) Instead of 'Suresh will find' in the part (A), 'Suresh finds' would be used because when in future, two events are mentioned, then **simple present tense** is used in the **conditional clause or subordinate clause** (the ones which start with when, if, before, after, until etc.), and **the future tense** is used in the **principal clause**.
So, there is an error in the part (A) of the sentence. Hence, option (1) is the correct answer.
9. (3) A **present tense** is used to convey 'present habit'. So, instead of 'she is getting up' in the part (C), 'she gets up' would be used. Hence, there is an error in the part (C) of the sentence and option (3) is the correct answer.
10. (3) Instead of 'have', 'has' would be used because the principle subject of the sentence is 'Seema' which is a **singular noun**. When two subjects are connected through 'as well as, in addition to, like, unlike, accompanied by, with, together with, along with' etc. Then, the noun or noun-equivalent which appears before such words is the principle noun and the form of the verb would be decided by the principle subject. Hence, there is an error in the part (C), and option (3) is the correct answer.
11. (2) The paragraph describes about the release of a documentary "Searching for Saraswati". It further mentions all the cast and the storyline of the documentary. The most appropriate pair of words that may fill the blank is "released / broadcasted". Both the words are apt to provide coherence to the paragraph. Since, all the other pairs of words fail to form a meaningful paragraph, option (2) is the most suitable answer choice.
12. (4) The paragraph describes about the release of a documentary "Searching for Saraswati". It further mentions all the cast and the storyline of the documentary. It is to be noted the phrase "well made" compliments the documentary, therefore the word connected to this phrase with the conjunctions "and" should also denote positive meaning. Therefore the pair with both the words satisfying this rationale is "engaging/engrossing" which means absorb all the

attention or interest of. Hence, option (4) is the most suitable answer choice.

Tedious means too long, slow, or dull; tiresome or monotonous.

Captivating means capable of attracting and holding interest; charming.

Taming means make less powerful and easier to control.

13. (5) The paragraph describes about the release of a documentary "Searching for Saraswati". It further mentions all the cast and the storyline of the documentary. The most suitable pair of word that will fill the blank is "captures/records" as they form a grammatically correct and contextually meaningful paragraph. All the other pairs of words are incoherent; hence, option (5) is the most suitable answer choice.

14. (1) The paragraph describes about the release of a documentary "Searching for Saraswati". It further mentions all the cast and the storyline of the documentary. The most suitable pair of word that will fill the blank is "deftly / proficiently" as they form a grammatically correct and contextually meaningful paragraph. All the other pairs of words are incoherent; hence, option (1) is the most suitable answer choice.

Deftly means in a way that is neatly skillful and quick in movement.

Proficiently means competent or skilled in doing or using something.

Ineptly means without skill or aptitude for a particular task or assignment

Crudely means in an offensively coarse or rude way, especially in relation to sexual matters.

Clumsily means in an awkward and careless way.

15. (3) The paragraph describes about the release of a documentary "Searching for Saraswati". It further mentions all the cast and the storyline of the documentary. The most suitable pair of word that will fill the blank is "swooping / pouncing" as they form a grammatically correct and contextually meaningful paragraph. All the other pairs of words are incoherent; hence, option (3) is the most suitable answer choice.

Swooping means carry out a sudden attack, especially in order to make a capture or arrest.

Pouncing means spring forward suddenly so as to attack or seize someone or something.

Raiding means quickly and illicitly take something from (a place).

16. (2) Arjun was one of the Pandav brothers having the eldest brother Dharamraj Yudhishtir. Therefore, Arjun wanted to remain loyal to his eldest brother who has the first right over the throne being the eldest son of the family. Refer to the first line of the 5th paragraph "He could have been a great king in his own right, but he remained loyal to his elder brother Dharmaraj Yudhishtir who ascended the throne of Hastinapur by virtue of being the eldest in the family."

All the other options describe the characteristics of Arjun but fail to provide the precise reason. Hence, option (2) is the most suitable answer choice.

17. (4) In an agreement with Kaurwas, Pandavs accepted an exile of thirteen years i.e. to wander twelve years in forests while in the thirteenth year they had to disguise themselves. Arjun choose to transform himself as

Brihannala. Following points helped him to disguise himself

- (i) The curse of Urvashi that transformed Arjun into a eunuch for a year.

Refer to the 3rd line of the 4th paragraph "Arjuna took advantage of the curse he got from Urvashi and turned himself into Brihannala, a eunuch and acted as dance master for the royal household, especially Uttara, the daughter of Virat."

- (iii) Arjun has excellent skills in the arts of dancing, singing and acting.

Refer to the first line of the 4th paragraph "Apart from archery, he also excelled in the arts of dancing, singing and acting which enormously helped the Pandavas when they had to stay in the court of Virat in total disguise as a part of their agreement with the Kauravas in the thirteenth year of their exile."

Hence, option (4) is the most suitable answer choice.

18. (3) Subhadra, Chitrangada and Draupdi were the wives of Arjun, however, Uttara was the wife Arjun and Subhadra's son Abhimanyu. Refer to the sixth line of the 4th paragraph "After realizing that the five people who were working in his court were indeed Pandavas in disguise, king Virat offered to marry his daughter to Abhimanyu the son of Arjuna in return for the services rendered by the brothers". Hence, option (3) is the most viable answer choice.

19. (3) Options (I) (II) and (IV) are described in the passage. **Conscientious** means wishing to do one's work or duty well and thoroughly.

Combatant means a person or nation engaged in fighting during a war.

Devotee means a person who is very interested in and enthusiastic about someone or something.

Refer to the last line of the passage "Arjuna serves as an example of a great human being, a dutiful householder, a loyal brother, a great warrior, a devout husband and a sincere devotee of God."

However, earnest means resulting from or showing sincere and intense conviction. The passage has not described anywhere regarding the firm beliefs of Arjun. Hence, option (3) is the most suitable answer choice.

20. (3) All the given statements are true in context of the passage, except for option (3).

For option (1) refer to 2nd line of 1st paragraph "He was born to Kunti and and king Pandu with the energy of Indra, the leader of the gods".

For option (2) refer to the last line of 2nd paragraph "They were Abhimnyu through Subhadra and Bhabhruvahana through Chitrangada. Both his sons played an important role during the Mahabharata war."

For option (4), refer to the 2nd line of the last paragraph "After the battle of Mahabharata, he assisted his brother greatly in expanding their empire by annexing several outlying kingdoms and defeating warring tribes."

For option (5) Refer to the 3rd line of 3rd paragraph "During the same period he met with Indra and other gods in the heavens from whom he received training and also helped them in return by slaying some asuras."

Grand Test – ICP 181130



However, option (3) is not true. Refer to the 4th line of 3rd paragraph **“While he was in the heavens he displeased Urvashi, the heavenly nymph, by turning away her advances.”**

Hence, option (3) is the most suitable answer choice.

21. (1) Wedlock means the state of being married. Nuptial means relating to marriage or weddings. Since both the words are synonyms of each other, option (1) is the most suitable answer choice.

Hurdle means a problem or difficulty that must be overcome.

Godsend means a very helpful or valuable event, person, or article.

22. (2) Pursuing means seek to attain or accomplish (a goal) over a long period. Seeking means attempt or desire to obtain or achieve (something). Since both the words are synonyms of each other, option (2) is the most suitable answer choice.

Fleeing means run away from a place or situation of danger.

Assembling means (of people) gather together in one place for a common purpose.

23. (5) Exile means the state of being barred from one's native country, typically for political or punitive reasons. Banishment means the punishment of being sent away from a country or other place. Since both the words are synonyms of each other, option (5) is the most suitable answer choice.

Compliance means the action or fact of complying with a wish or command.

Domicile means the country that a person treats as their permanent home, or lives in and has a substantial connection with.

Salutation means a gesture or utterance made as a greeting or acknowledgement of another's arrival or departure.

24. (4) Crucial means decisive or critical, especially in the success or failure of something. Insignificant means too small or unimportant to be worth consideration. Since both the words are antonyms of each other, option (4) is the most suitable answer choice.

Requisite means made necessary by particular circumstances or regulations.

Compelling means evoking interest, attention, or admiration in a powerfully irresistible way

Pivotal means of crucial importance in relation to the development or success of something else.

25. (2) Humility means the quality of having a modest or low view of one's importance. Vanity means excessive pride in or admiration of one's own appearance or achievements. Since both the words are antonyms of each other, option (2) is the most suitable answer choice.

Diffidence means modesty or shyness resulting from a lack of self-confidence.

Timidity means lack of courage or confidence.

26. (2) All the sentences are grammatically correct and contextually meaningful except for sentence (2). Though, ‘signature’ is a noun, still the appropriate noun which should follow the preposition ‘by’ is the gerund-form of ‘sign’—signing. Hence, option (2) is the most suitable answer choice.

27. (3) All the sentences are grammatically correct and contextually meaningful except for sentence (3). It is to be noted that “it’s” is always the abbreviation of “it is”. “Its” is the possessive of “it”. To make the sentence contextually meaningful, the possessive of “it” should be used i.e. “its”. Hence, option (3) is the most suitable answer choice.

28. (2) All the sentences are grammatically correct and contextually meaningful except for sentence (2). It is to be noted that “quickly” is an adverb while the context of the sentence requires an adjective to describe the quality of the “action”. Since, sentence (2) is incorrect, option (2) becomes the most viable answer choice.

29. (5) All the given sentences are grammatically correct and contextually meaningful. Therefore, option (5) is the most suitable answer choice.

30. (4) All the sentences are grammatically correct and contextually meaningful except for sentence (4). Phrases such as together with, as well as, and along with are not the same as ‘and’. The phrase introduced by ‘as well as’ or ‘along with’ will modify the earlier word, but it does not compound the subjects (as the word ‘and’ would do). Therefore, when (the head word of) the subject is separated from the verb by expressions starting with words such as ‘along with’, ‘as well as’, and ‘besides’, ignore these expressions when determining whether to use a singular or plural verb. Thus, “play” should be replaced by its singular form “plays”. Hence, option (4) is the most suitable answer choice.

31. (1) $(?)^2 = 24 + 31 + 729$

$(?)^2 = 784$

$(?)^2 = (28)^2$

$? = 28$

32. (1) $\frac{1250}{25} - \frac{180}{6} = ?$

$50 - 30 = ?$

$? = 20$

33. (2) $\sqrt{?} \times 12 = 132$

$\sqrt{?} \times 11$

$? = 121$

34. (5) $(3)^? \times 6 = 2136 - 1974 + 81 + 1215$

$(3)^? = \frac{1458}{6} = 243$

$(3)^? = (3)^5$

$? = 5$

35. (3) $? = 1718 - 1220 + 31 - 219 = 310$

36-40. Marks obtained X in Physics = 160

Total marks obtained by X = $\frac{160}{40} \times 100 = 400$

Marks obtained by X in Chemistry & Maths together = $400 - 160 = 240$

Total marks obtained by Z = $\frac{400}{4} \times 3 = 300$

Marks obtained by Z in Chemistry = $\frac{3}{4} \times 160 = 120$

Marks obtained by Z in Physics and Maths = $300 - 120 = 180$

Marks obtained by Y in Maths = 120

Marks obtained by Y in Physics and Chemistry together

$= \frac{400}{2} = 200$

Total marks obtained by Y = $200 + 120 = 320$

Student \ Subject	X	Y	Z
Physics	160] 200	120
Chemistry] 240		
Maths		120] 180
Total	400	320	

Grand Test – ICP 181130



36. (3) Let marks obtained by X in Chemistry be a.

ATQ,

$$a + \frac{150}{100}a = 240$$

$$a = 96$$

$$\text{Required difference} = 96 \times 1.5 - 120$$

$$= 144 - 120 = 24$$

37. (1) Required % = $\frac{200}{300} \times 100 = 66 \frac{2}{3}\%$

38. (3) Cannot be determined

39. (3) Required % = $\frac{320}{600} \times 100 = 53 \frac{1}{3}\%$

40. (5) Marks obtained by Z in Physics

$$= 180 \times \frac{2}{3} = 120$$

$$\text{Required average} = \frac{120+160}{2} = 140$$

41. (4) Pattern is,

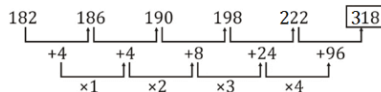

42. (1) Pattern is

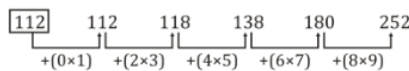

43. (4) 3448, 3450, 1728, 580, 150, 36. Differences: +1+2, +2+3, +3+4, +4+5, +5+6.

44. (5) Pattern is

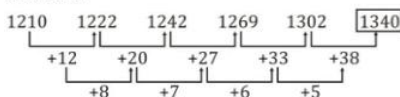

45. (1) Pattern is

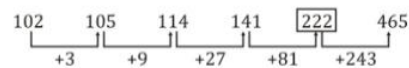

46. (2) Required ratio = $\frac{270+1125}{1240} = 9 : 8$
Approach to solve the ratio

After putting the values we obtained the ratio as 1395 : 1240

And after simplifying it we obtained 279 : 248

We are not able to simplify it further easily because it is a multiple of 31

To solve this type of ratio take difference of numerator and denominator of the ratio

Given ratio will be a multiple of this difference or a multiple of the factors of this difference, if not then ratio cannot be simplified further.

Eg. 279- 248 = 31

And we find that it ratio is a multiple of 31 and after further simplifying it we get 9 : 8

47. (2) Total number of animals in Kaziranga national park = 180 + 820 + 2200 = 3200

Total number of animals in Gir national park = 210+1240+2150= 3600

$$\text{Required \%} = \frac{3600-3200}{3600} \times 100\% = \frac{100}{9}\% = 11 \frac{1}{9}\%$$

48.(3) Number of Birds in Jim Corbett national park = $\frac{3105}{15} \times 6 = 1242$

Number of Birds in Gir national park = $\frac{2150}{43} \times 20 = 1000$

$$\text{Required difference} = \{(1240 + 1125) - (1242 + 1000)\} = 123$$

49. (1) Total number of tigers in these two parks = 210 + 175 = 385

Total number of animals in these two national parks

$$= (210+1240+2150) + (175+925+1900) = 6600$$

$$\text{Required \%} = \frac{385}{6600} \times 100\% = \frac{35}{6}\% = 5 \frac{5}{6}\%$$

50. (4) Required difference = $\frac{1}{2} \{ (1240 + 820) - (1125 + 925) \} = 5$

$$\Rightarrow 9 \times 19 + (38)^2 = ?$$

$$\Rightarrow ? = 1615$$

52. (4) $\left[(512)^{\frac{1}{2}} + (256)^{\frac{1}{2}} \right] = ? + 5$
 $8 + 16 - 5 = ?$
 $? = 19$

53. (4) $\frac{2}{15-?} \times \frac{40}{100} \times 650 = 65$
 $\frac{2}{15-?} \times 260 = 65$
 $\frac{2}{15-?} = \frac{65}{260}$
 $\frac{2}{15-?} = \frac{1}{4}$
 $8 = 15 - ?$
 $? = 15 - 8$
 $? = 7$

54. (2) $\frac{30}{100} \times 570 \times 2 = ?^2 - 19$
 $171 \times 2 = ?^2 - 19$
 $342 + 19 = ?^2$
 $?^2 = 361$
 $? = 19$

55. (3) $\left[(13824)^{\frac{1}{3}} \right]^2 = ? + 231$
 $[24]^2 = ? + 231$
 $? = 345$

56. (1) Simple interest = $\frac{3}{20} \times 18000 = 2700$
 $R = \frac{2700 \times 100 \times 2}{18000 \times 5} = 6\%$

57. (3) Cost price of mixture = $357 \times \frac{100}{120}$
 $= \text{Rs } \frac{595}{2}$

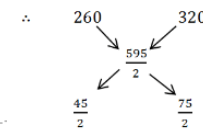

$$\frac{x}{(x+8)} = \frac{3}{5} \Rightarrow x = 12 \text{ kg}$$

58. (5) $40 \times P = 75 \times Q$
 $\Rightarrow 8P = 15Q$

$$\text{Required percent} = \frac{15 \times 15Q}{20Q} \times 100 = 112 \frac{1}{2}\%$$

59. (2)

Let the speed of boat in still water be x km/hr and that of stream be y km/hr.

ATQ

$$(x + y) - (x - y) = 5$$

$$\Rightarrow y = 2.5 \text{ km/hr}$$

$$x = 2.5 \times 3.80 = 9.5 \text{ km/hr}$$

$$\text{required time} = \frac{42}{(9.5+2.5)} + \frac{31.5}{(9.5-2.5)} = 8 \text{ hr}$$

60. (4)

Let present age of Ayush be x years and that of Veer be y years

ATQ,

$$\frac{x+1}{y-5} = \frac{1}{1}$$

$$\Rightarrow x - y = -6 \dots (i)$$

And,

$$x + y = 54 \dots (ii)$$

From (i) and (ii)

$$x = 24 \text{ years and } y = 30 \text{ years}$$

$$\text{Required ratio} = \frac{30}{24} = 5 : 4$$

61. (4)

$$64 \times (200 - 2) + \frac{20}{2} = x$$

or, $12800 - 128 + 10 = x$
or, $x = 12682$

62. (2)

$$62 \times \frac{100}{31 \times 200} + x = 4$$

or, $1 + x = 4$
or, $x = 3$

63. (1)

$$1728 \times \frac{1}{12^3} - 11^3 = x$$

or, $1728 \times \frac{1}{1728} - 1331 = x$
or, $x = -1330$

64. (3)

$$729 \times \frac{1}{81} - 24 \times \frac{100}{3 \times 10} = x$$

or, $9 - 80 = x$
or, $x = -71$

Grand Test – ICP 181130



65. (2) $1120 (1001 - 999) + 55 = x$
 or, $1120 \times 2 + 55 = x$
 or, $2240 + 55 = x$
 or, $x = 2295$

66-68. $O > K(150,000) > M > J > L (50,000) > N$

- 66. (3)
- 67. (2)
- 68. (1)
- 69. (1)



70. (2)

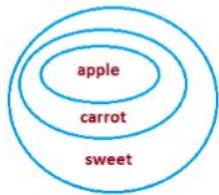

71-75.

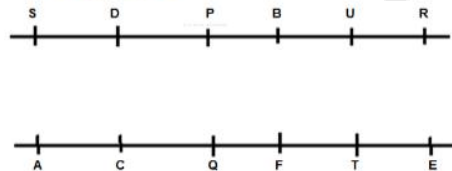

- 71. (5)
- 72. (4)
- 73. (5)
- 74. (1)
- 75. (3)

76-80.

Only one person sit between U and P. S sits immediate right of V neither of them is an immediate neighbour of U and P. Q sits second to the right of S.

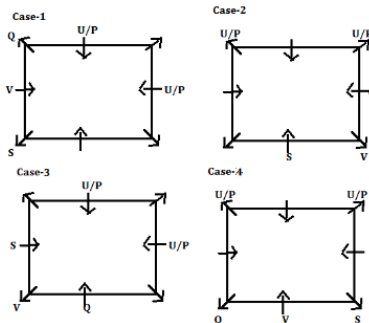

W sits second to the left of R and both of them sit at the corners of the table. R is not an immediate neighbour of S. So, from this case-2 and 4 will get eliminated.

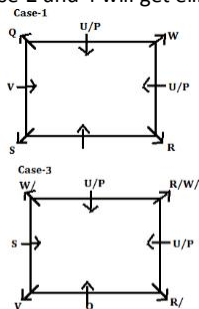

T neither sit on the middle side of the table nor sit opposite to R. U is not an immediate neighbour of T. So,

from this case-1 gets eliminated. And the final arrangement is----

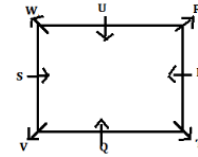

- 76. (2)
- 77. (3)
- 78. (1)
- 79. (1)
- 80. (2)
- 81. (2) 437 562 593 628 723
- 82. (3) 953 732 743 652 862
- 83. (1) 11 6 0 9 0
- 84. (1)
- 85. (1) 359 237 347 256 268
- 86. (1) I. $N < F$ (false) II. $P > M$ (true)

- III. $M < N$ (true) IV. $A = P$ (false)
- 87. (1) I. $C < E$ (true) II. $O \leq Q$ (false)
- III. $G > W$ (false) IV. $C > G$ (false)
- 88. (4) I. $T > H$ (true) II. $R > D$ (true)
- III. $S < R$ (true) IV. $H < D$ (false)
- 89. (4) I. $V > N$ (true) II. $Z \leq U$ (false)
- III. $U > X$ (true) IV. $J > Y$ (true)
- 90. (2) I. $R > K$ (false) II. $J > L$ (false)
- III. $A > O$ (false) IV. $O \geq A$ (false)

91-95.

Month	Persons
March	F
April	B
May	D
June	A
August	C
October	G
December	E

- 91. (2)
- 92. (5)
- 93. (4)
- 94. (2)
- 95. (2)

96-98.

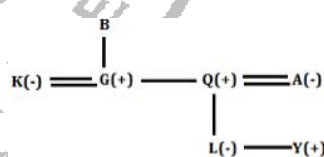

- 96. (2)
- 97. (4)
- 98. (2)

99-100.

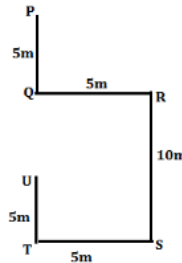

- 99. (2)
- 100. (5)